



SERVICE AND OPERATING MANUAL
Models HDF3-A Type 7
HDF4-A Type 3

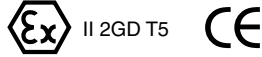

Table of Contents

| | |
|-------------------------------------------------------------------|-----|
| Principle of Operation..... | 1 |
| Installation and Start-Up..... | 1 |
| Air Supply | 1 |
| Air Inlet & Priming..... | 1 |
| ESADS+Plus®: Externally Serviceable Air Distribution System | 2 |
| Pilot Valve | 3 |
| Pilot Valve Actuator..... | 3 |
| Air Exhaust | 3 |
| Between Uses | 3 |
| Flap Valve Servicing | 3 |
| Diaphragm Servicing | 3 |
| Reassembly..... | 3 |
| Service Instructions: Troubleshooting | 4 |
| Warranty | 4 |
| Grounding The Pump | 5 |
| Important Safety Information | 6 |
| Recycling..... | 6 |
| Material Codes | 7 |
| Composite Repair Parts List..... | 8-9 |
| Composite Repair Drawing..... | 10 |

**WARREN
RUPP®**



Warren Rupp, INC. • A Unit of IDEX Corporation • P.O. Box 1568, Mansfield, Ohio 44901-1568 USA
Phone (419) 524-8388 • Fax (419) 522-7867 • www.warrenrupp.com

PRINCIPLE OF PUMP OPERATION

This flap swing check valve pump is powered by compressed air and is a 1:1 pressure ratio design. It alternately pressurizes the inner side of one diaphragm chamber, while simultaneously exhausting the other inner chamber. This causes the diaphragms, which are connected by a common rod, to move endwise. Air pressure is applied over the entire surface of the diaphragm, while liquid is discharged from the opposite side. The diaphragm operates under a balanced condition during the discharge stroke, which allows the unit to be operated at discharge heads over 200 feet (61 meters) of water head.

Since the diaphragms are connected by a common rod, secured by plates to the center of the diaphragms, one diaphragm performs the discharge stroke, while the other is pulled to perform the suction stroke in the opposite chamber.

For maximum diaphragm life, keep the pump as close to the liquid being pumped as possible. Positive suction head in excess of 10 feet of liquid (3.048 meters) may require a back pressure regulating device. This will maximize diaphragm life.

Alternate pressuring and exhausting of the diaphragm chamber is performed by means of an externally mounted, pilot operated, four-way spool type air distribution valve. When the spool shifts to one end of the valve body, inlet air pressure is applied to one diaphragm chamber and the other diaphragm chamber exhausts. When the spool shifts to the opposite end of the valve body, the porting of chambers is reversed. The air distribution valve spool is moved by an internal pilot valve which alternately pressurizes one side of the air distribution valve spool, while exhausting the other side. The pilot valve is shifted at each end of the diaphragm stroke by the diaphragm plate coming in contact with the end of the pilot valve spool. This pushes it into position for shifting of the air distribution valve.

The chambers are manifolded together with a suction and discharge check valve for each chamber, maintaining flow in one direction through the pump.

INSTALLATION & START-UP

Locate the pump as close to the product being pumped as possible, keeping suction line length and number of fittings to a minimum. Do not reduce line size.

For installations of rigid piping, short flexible sections of hose should be installed between pump and piping. This reduces vibration and strain to the piping system. A Warren Rupp Tranquilizer[®] Surge Suppressor is recommended to further reduce pulsation in flow.

This pump was tested at the factory prior to shipment and is ready for operation. It is completely self-priming from a dry start for suction lifts of 20 feet (6.096 meters) or less. For suction lifts exceeding 20 feet of liquid, fill the chambers with liquid prior to priming.

AIR SUPPLY

Air supply pressures cannot exceed 125 psi (8.61 bar). Connect the pump air inlet to an air supply of sufficient capacity and pressure required for desired performance. When the air line is solid piping, use a short length of flexible hose (not less than 3/4" (19mm) in diameter) between pump and piping to eliminate strain to pipes.

AIR INLET & PRIMING

For start-up, open an air valve approximately 1/2" to 3/4" turn. After the unit primes, an air valve can be opened to increase flow as desired. If opening the valve increases cycling rate, but does not increase flow rate, cavitation has occurred, and the valve should be closed slightly.

For the most efficient use of compressed air and the longest diaphragm life, throttle the air inlet to the lowest cycling rate that does not reduce flow.

AIR VALVE LUBRICATION

The Sandpiper pump's pilot valve and main air valve assemblies are designed to operate WITHOUT lubrication. This is the preferred mode of operation. There may be instances of personal preference, or poor quality air supplies when lubrication of the compressed air supply is required. The pump air system will operate with properly lubricated compressed air supplies. Proper lubrication of the compressed air supply would entail the use of an air line lubricator (available from Warren Rupp) set to deliver one drop of 10 weight, non-detergent oil for every 20 SCFM of air the pump consumed at its point of operation. Consult the pump's published Performance Curve to determine this.

It is important to remember to inspect the sleeve and spool set routinely. It should move back and forth freely. This is most important when the air supply is lubricated. If a lubricator is used, oil accumulation will, over time, collect any debris from the compressed air. This can prevent the pump from operating properly.

Water in the compressed air supply can create problems such as icing or freezing of the exhaust air causing the pump to cycle erratically, or stop operating. This can be addressed by using a point of use air dryer (available from Warren Rupp) to supplement a plant's air drying equipment. This device will remove excess water from the compressed air supply and alleviate the icing or freezing problem.

Externally Serviceable Air Distribution System

Please refer to the exploded view drawing and parts list in the Service Manual supplied with your pump. If you need replacement or additional copies, contact your local Warren Rupp Distributor, or the Warren Rupp factory Literature Department at the number shown below. To receive the correct manual, you must specify the MODEL and TYPE information found on the name plate of the pump.

Models with 1" suction/discharge or larger and METAL center sections

The main air valve sleeve and spool set is located in the valve body mounted on the pump with four hex head capscrews. The valve body assembly is removed from the pump by removing these four hex head capscrews.

With the valve body assembly off the pump, access to the sleeve and spool set is made by removing four hex head capscrews (each end) on the end caps of the valve body assembly. With the end caps removed, slide the spool back and forth in the sleeve. The spool is closely sized to the sleeve and must move freely to allow for proper pump operation. An accumulation of oil, dirt or other contaminants from the pump's air supply, or from a failed diaphragm, may prevent the spool from moving freely. This can cause the spool to stick in a position that prevents the pump from operating. If this is the case, the sleeve and spool set should be removed from the valve body for cleaning and further inspection.

Remove the spool from the sleeve. Using an arbor press or bench vise (with an improvised mandrel), press the sleeve from the valve body. Take care not to damage the sleeve. At this point, inspect the o-rings on the sleeve for nicks, tears or abrasions. Damage of this sort could happen during assembly or servicing. A sheared or cut o-ring can allow the pump's compressed air supply to leak or bypass within the air valve assembly, causing the pump to leak compressed air from the pump air exhaust or not cycle properly. This is most noticeable at pump dead head or high discharge pressure conditions. Replace any of these o-rings as required or set up a routine, preventive maintenance schedule to do so on a regular basis. This practice should include cleaning the spool and sleeve components with a safety solvent or equivalent, inspecting for signs of wear or damage, and replacing worn components.

To re-install the sleeve and spool set, lightly lubricate the o-rings on the sleeve with an o-ring assembly lubricant or lightweight oil (such as 10 wt. air line lubricant). Press the set into the valve body easily, without shearing the o-rings. Re-install one end cap, gasket and bumper on the valve body. Using the arbor press or bench vise that was used in disassembly, press the sleeve back into the valve body. You may have to clean the surfaces of the valve body where the end caps mount. Material may remain from the old gasket. Old material not cleaned from this area may cause air leakage after reassembly. Take care that the bumper stays in place allowing the sleeve to press in all the way. Reinstall the spool, the opposite end cap, gasket and bumper on the valve body. After inspecting and cleaning the gasket surfaces on the valve body and intermediate, reinstall the valve body on the pump using new gaskets. Tighten the four hex head capscrews evenly and in an alternating cross pattern.

PILOT VALVE

The pilot valve assembly is accessed by removing the main air distribution valve body from the pump and lifting the pilot valve body out of the intermediate housing.

Most problems with the pilot valve can be corrected by replacing the o-rings. Always grease the spool prior to inserting it into the sleeve. If the sleeve is removed from the body, reinsertion must be at the chamfered side. Grease the o-rings to slide the sleeve into the valve body. Securely insert the retaining ring around the sleeve. When reinserting the pilot valve, push both plungers (located inside the intermediate bracket) out of the path of the pilot valve spool ends to avoid damage.

PILOT VALVE ACTUATOR

Bushings for the pilot valve actuators are threaded into the intermediate bracket from the outside. The plunger may be removed for inspection or replacement. First remove the air distribution valve body and the pilot valve body from the pump. The plungers can be located by looking into the intermediate. It may be necessary to use a fine piece of wire to pull them out. The bushing can be turned out through the inner chamber by removing the outer chamber assembly. Replace the bushings if pins have bent.

AIR EXHAUST

If a diaphragm fails, the pumped liquid or fumes can enter the air end of the pump, and be exhausted into the atmosphere. When pumping hazardous or toxic materials, pipe the exhaust to an appropriate area for safe disposition.

This pump can be submerged if materials of construction are compatible with the liquid. The air exhaust must be piped above the liquid level. Piping used for the air exhaust must not be smaller than 1" (2.54 cm). Reducing the pipe size will restrict air flow and reduce pump performance. When the product source is at a higher level than the pump (flooded suction), pipe the exhaust higher than the product source to prevent siphoning spills.

Freezing or icing-up of the air exhaust can occur under certain temperature and humidity conditions. Use of a Warren Rupp Extractor/Dryer unit should eliminate most icing problems.

BETWEEN USES

When used for materials that tend to settle out or transform to solid form, the pump should be completely flushed after each use, to prevent damage. Product remaining in the pump between uses could dry out or settle out. This could cause problems with valves and diaphragms at re-start. In freezing temperatures, the pump must be drained between uses in all cases.

CHECK VALVE SERVICING

For flap valve inspection or replacement, remove the flange bolts securing the suction and discharge elbows and loosen Dresser-type couplings. The flap valves are exposed for inspection or servicing upon removal of elbows.

DIAPHRAGM SERVICING

Diaphragms are serviced by removing the outer diaphragm chambers which are secured with 12 bolts. After removing the outer chamber, unbolt the diaphragm plate by removing 6 socket head capscrews (Allen wrench required). To remove the diaphragm rod, remove the inner diaphragm plate secured by a nut on the end of the diaphragm rod. The opposite diaphragm and rod can then be removed as a unit. The interior components consisting of sleeve bearings, rod seals, and pilot valve actuator bushings are now accessible for service if required.

REASSEMBLY

All procedures for reassembling the pump are the reverse of the above with these further instructions:

1. Install the diaphragms with their natural bulge outward. Make certain that the rubber diaphragm rod bumper is installed on the rod behind each inner diaphragm plate. Re-torque the 6 socket head capscrews that secure the diaphragm between the plates to 30 foot lbs. (40.67 Newton meters) torque reading.

2. Caution should be used while reassembling the check valves. The valves are designed for some preload over the retainer and the hinge pad. This is done to insure proper face contact with the seat. After all parts are in place, tighten the lock nuts down on the assembly to the point where visual inspection shows that seat and valve face mate without gap. This is important for dry primes. However, after priming action has started, valves will function due to differential pressure without concern or trouble.

TROUBLE SHOOTING

PROBLEM: Pump cycles but will not pump. (Note: higher suction lifts require faster cycling speed for priming.)

POSSIBLE CAUSES:

- A. Air leak in suction line.
- B. Excessive suction lift.
- C. Check valve not closing.
- D. Leakage at joint of suction manifold or elbow flange.
- E. Suction line plugged.
- F. Diaphragm ruptured.

PROBLEM: Pump will not cycle. (Note: Always disconnect air supply to relieve air pressure before disassembling any portion of pump.)

POSSIBLE CAUSES:

- A. Discharge hose or line plugged, or discharge head requirement greater than air pressure. (Disconnect discharge line to check.)
- B. Spool in air distribution valve not shifting. (Remove end cap and check spool - must slide freely.)
- C. Diaphragm ruptured. (Air will escape out discharge line in this case.)
- D. Blockage in diaphragm chamber preventing movement. (Shut off air supply and reopen after pressure is relieved.)
- E. Plugged or dirty exhaust muffler.

PROBLEM: Uneven discharge flow. (Indicates one chamber not operating properly.)

POSSIBLE CAUSES:

- A. Check valve not sealing properly in one chamber.
- B. Diaphragm failure in one chamber.
- C. Air leak at suction manifold joint or elbow flange one side.

For additional information, see the Warren Rupp Troubleshooting Guide.

WARRANTY

This pump is warranted for a period of five years against defective material and workmanship. Failure to comply with the recommendations stated in this manual voids all factory warranty.

RECOMMENDED WARREN RUPP ACCESSORIES TO MAXIMIZE PUMP PERFORMANCE:

- **Tranquillizer® Surge Suppressor.** For nearly pulse-free flow.
- **Warren Rupp Air Dryer.** For clean, dry compressed air.
- **Warren Rupp Filter/Regulator.** For modular installation and service convenience.
- **Warren Rupp Speed Control.** For manual or programmable process control. Manual adjustment or 4-20mA reception.

For more detailed information on these accessories, contact your local Warren Rupp Factory-Authorized Distributor, or Warren Rupp corporate headquarters.

Grounding The Pump

⚠ WARNING ⚠

Take action to prevent static sparking. Fire or explosion can result, especially when handling flammable liquids. The pump, piping, valves, containers or other miscellaneous equipment must be grounded.

One eyelet is fastened to the pump hardware.

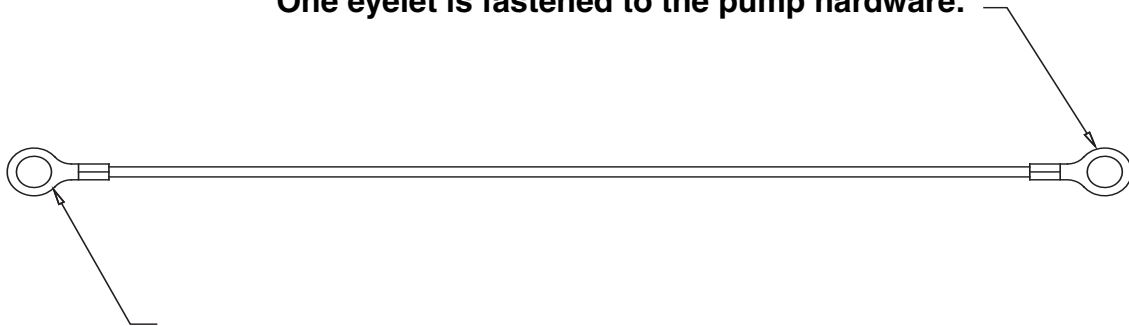

One eyelet is installed to a true earth ground.

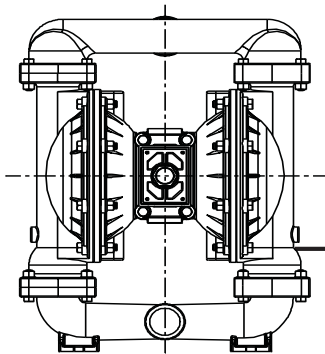

This 8 foot long (244 centimeters) Ground Strap, part number 920.025.000 can be ordered as a service item.

To reduce the risk of static electrical sparking, this pump must be grounded. Check the local electrical code for detailed grounding instruction and the type of equipment required, or in the absence of local codes, an industry or nationally recognized code having jurisdiction over specific installations.

Recycling

Many components of SANDPIPER® Metallic AODD pumps are made of recyclable materials (see chart on page 10 for material specifications). We encourage pump users to recycle worn out parts and pumps whenever possible, after any hazardous pumped fluids are thoroughly flushed.



Pump complies with EN809 Pumping Directive and Directive 98/37/EC Safety of Machinery, and ATEX 100a Directive 94/9/EC Equipment for use in Potentially Explosive Environments. For documentation consult the manufacturer or visit: www.warrenrupp.com



⚠ IMPORTANT

Read these safety warnings and instructions in this manual completely, before installation and start-up of the pump. It is the responsibility of the purchaser to retain this manual for reference. Failure to comply with the recommendations stated in this manual will damage the pump, and void factory warranty.



⚠ CAUTION

Before pump operation, inspect all gasketed fasteners for looseness caused by gasket creep. Retorque loose fasteners to prevent leakage. Follow recommended torques stated in this manual.



⚠ WARNING

Before maintenance or repair, shut off the compressed air line, bleed the pressure, and disconnect the air line from the pump. The discharge line may be pressurized and must be bled of its pressure.



⚠ WARNING

In the event of diaphragm rupture, pumped material may enter the air end of the pump, and be discharged into the atmosphere. If pumping a product which is hazardous or toxic, the air exhaust must be piped to an appropriate area for safe disposition.



⚠ WARNING

Take action to prevent static sparking. Fire or explosion can result, especially when handling flammable liquids. The pump, piping, valves, containers or other miscellaneous equipment must be grounded. (See page 6).



⚠ WARNING

POSSIBLE EXPLOSION HAZARD can result if 1, 1, 1,-Trichloroethane, Methylene Chloride or other Halogenated Hydrocarbon solvents are used in pressurized fluid systems having Aluminum or Galvanized wetted parts. Death, serious bodily injury and/or property damage could result. Consult with the factory if you have questions concerning Halogenated Hydrocarbon solvents.



⚠ WARNING

This pump is pressurized internally with air pressure during operation. Always make certain that all bolting is in good condition and that all of the correct bolting is reinstalled during assembly.



⚠ WARNING

When used for toxic or aggressive fluids, the pump should always be flushed clean prior to disassembly.



⚠ WARNING

Before doing any maintenance on the pump, be certain all pressure is completely vented from the pump, suction, discharge, piping, and all other openings and connections. Be certain the air supply is locked out or made non-operational, so that it cannot be started while work is being done on the pump. Be certain that approved eye protection and protective clothing are worn all times in the vicinity of the pump. Failure to follow these recommendations may result in serious injury or death.



⚠ WARNING

Airborne particles and loud noise hazards. Wear ear and eye protection.

MATERIAL CODES

THE LAST 3 DIGITS OF PART NUMBER

| | | | | | |
|-----|------------------------------------------------------|-----|----------------------------------------------------------------------|-----|----------------------------------------------------------|
| 000 | Assembly, sub-assembly; and some purchased items | 337 | Silver Plated Steel | 555 | Polyvinyl Chloride |
| 010 | Cast Iron | 340 | Nickel Plated | 556 | Black Vinyl |
| 012 | Powered Metal | 342 | Filled Nylon | 558 | Conductive HDPE |
| 015 | Ductile Iron | 351 | Food Grade Santoprene | 570 | Rulon II |
| 020 | Ferritic Malleable Iron | 353 | Geolast; Color: Black | 580 | Ryton |
| 025 | Music Wire | 354 | Injection Molded #203-40 Santoprene- Duro 40D +/-5; Color: RED | 590 | Valox |
| 080 | Carbon Steel, AISI B-1112 | | | 591 | Nylatron G-S |
| 100 | Alloy 20 | 355 | Thermal Plastic | 592 | Nylatron NSB |
| 110 | Alloy Type 316 Stainless Steel | 356 | Hytrel | 600 | PTFE (virgin material) Tetrafluorocarbon (TFE) |
| 111 | Alloy Type 316 Stainless Steel (Electro Polished) | 357 | Injection Molded Polyurethane | 601 | PTFE (Bronze and moly filled) |
| 112 | Alloy C | 358 | Urethane Rubber (Some Applications) (Compression Mold) | 602 | Filled PTFE |
| 113 | Alloy Type 316 Stainless Steel (Hand Polished) | | | 603 | Blue Gylon |
| 114 | 303 Stainless Steel | 359 | Urethane Rubber | 604 | PTFE |
| 115 | 302/304 Stainless Steel | 360 | Nitrile Rubber Color coded: RED | 606 | PTFE |
| 117 | 440-C Stainless Steel (Martensitic) | 361 | Nitrile | 607 | Envelon |
| 120 | 416 Stainless Steel (Wrought Martensitic) | 363 | FKM (Fluorocarbon). Color coded: YELLOW | 608 | Conductive PTFE |
| 123 | 410 Stainless Steel (Wrought Martensitic) | 364 | E.P.D.M. Rubber. Color coded: BLUE | 610 | PTFE Encapsulated Silicon |
| 148 | Hardcoat Anodized Aluminum | 365 | Neoprene Rubber. Color coded: GREEN | 611 | PTFE Encapsulated FKM |
| 149 | 2024-T4 Aluminum | 366 | Food Grade Nitrile | 632 | Neoprene/Hytrel |
| 150 | 6061-T6 Aluminum | 368 | Food Grade EPDM | 633 | FKM/PTFE |
| 151 | 6063-T6 Aluminum | 370 | Butyl Rubber Color coded: BROWN | 634 | EPDM/PTFE |
| 152 | 2024-T4 Aluminum (2023-T351) | | | 635 | Neoprene/PTFE |
| 154 | Almag 35 Aluminum | 371 | Philthane (Tuftane) | 637 | PTFE, FKM/PTFE |
| 155 | 356-T6 Aluminum | 374 | Carboxylated Nitrile | 638 | PTFE, Hytrel/PTFE |
| 156 | 356-T6 Aluminum | 375 | Fluorinated Nitrile | 639 | Nitrile/TFE |
| 157 | Die Cast Aluminum Alloy #380 | 378 | High Density Polypropylene | 643 | Santoprene®/EPDM |
| 158 | Aluminum Alloy SR-319 | 379 | Conductive Nitrile | 644 | Santoprene®/PTFE |
| 159 | Anodized Aluminum | 405 | Cellulose Fibre | 656 | Santoprene Diaphragm and Check Balls/EPDM Seats |
| 162 | Brass, Yellow, Screw Machine Stock | 408 | Cork and Neoprene | 661 | EPDM/Santoprene |
| 165 | Cast Bronze, 85-5-5-5 | 425 | Compressed Fibre | 666 | FDA Nitrile Diaphragm, PTFE Overlay, Balls, and Seals |
| 166 | Bronze, SAE 660 | 426 | Blue Gard | 668 | PTFE, FDA Santoprene/PTFE |
| 170 | Bronze, Bearing Type, Oil Impregnated | 440 | Vegetable Fibre | | |
| 175 | Die Cast Zinc | 465 | Fibre | | |
| 180 | Copper Alloy | 500 | Delrin 500 | | |
| 305 | Carbon Steel, Black Epoxy Coated | 501 | Delrin 570 | | |
| 306 | Carbon Steel, Black PTFE Coated | 502 | Conductive Acetal, ESD-800 | | |
| 307 | Aluminum, Black Epoxy Coated | 503 | Conductive Acetal, Glass-Filled | | |
| 308 | Stainless Steel, Black PTFE Coated | 505 | Acrylic Resin Plastic | | |
| 309 | Aluminum, Black PTFE Coated | 506 | Delrin 150 | | |
| 310 | PVDF Coated | 520 | Injection Molded PVDF Natural color | | |
| 313 | Aluminum, White Epoxy Coated | 540 | Nylon | | |
| 330 | Zinc Plated Steel | 541 | Nylon | | |
| 331 | Chrome Plated Steel | 542 | Nylon | | |
| 332 | Aluminum, Electroless Nickel Plated | 544 | Nylon Injection Molded | | |
| 333 | Carbon Steel, Electroless Nickel Plated | 550 | Polyethylene | | |
| 335 | Galvanized Steel | 551 | Glass Filled Polypropylene | | |
| 336 | Zinc Plated Yellow Brass | 552 | Unfilled Polypropylene | | |
| | | 553 | Unfilled Polypropylene | | |

Delrin and Hytrel are registered tradenames of E.I. DuPont.

Gylon is a registered tradename of Garlock, Inc.

Nylatron is a registered tradename of Polymer Corp.

Santoprene is a registered tradename of Monsanto Corp.

Rulon II is a registered tradename of Dixon Industries Corp.

Ryton is a registered tradename of Phillips Chemical Co.

Valox is a registered tradename of General Electric Co.

PortaPump, Tranquilizer and SludgeMaster are registered tradenames of Warren Rupp, Inc.

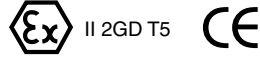

| ITEM NO. | PART NUMBER | DESCRIPTION | QTY. |
|----------|-------------|---------------------------------------------|------|
| 1 | 031.012.000 | SLEEVE & SPOOL SET | 1 |
| 2 | 070.006.170 | BEARING | 2 |
| 3 | 095.043.156 | BODY, AIR VALVE | 1 |
| 4 | 095.073.000 | ASSEMBLY, PILOT VALVE | 1 |
| 4-A | 095.070.551 | BODY, PILOT VALVE | 1 |
| 4-B | 560.023.360 | O-RING (SPOOL) | 2 |
| 4-C | 560.033.360 | O-RING | 4 |
| 4-D | 675.037.080 | RETAINING RING | 1 |
| 4-E | 755.025.000 | SLEEVE, PILOT VALVE | 1 |
| 4-F | 775.026.000 | SPOOL, PILOT VALVE | 1 |
| 5 | 114.002.156 | INTERMEDIATE | 1 |
| 6 | 115.020.080 | BRACKET, FOOT | 2 |
| 7 | 115.021.080 | BRACKET, FOOT | 2 |
| 8 | 132.002.360 | BUMPER, DIAPHRAGM PLATE | 2 |
| 9 | 132.014.358 | BUMPER, AIR VALVE | 2 |
| 10 | 135.016.162 | BUSHING, THREADED, W/ O-RING 560.001.360 | 2 |
| 11 | 165.011.157 | CAP, END | 2 |
| 12 | 170.012.330 | CAPSCREW, HEX HEAD 1/2-13 UNC X 2.00 | 8 |
| 13 | 170.023.330 | CAPSCREW, HEX HEAD | 4 |
| 14 | 170.024.330 | CAPSCREW, HEX HEAD, 7/16-14 X 1 | 8 |
| 15 | 170.032.330 | CAPSCREW, HEX HEAD | 8 |
| 16 | 170.045.330 | CAPSCREW HEX HEAD | 4 |
| 17 | 170.066.330 | CAPSCREW, HEX, 1/2-13 X 2.25 | 36 |
| 18 | 172.001.330 | CAPSCREW, SOCKET | 12 |
| 19 | 196.003.155 | CHAMBER, INNER | 2 |
| 20 | 196.004.155 | CHAMBER, OUTER | 2 |
| 21 | 286.018.354 | DIAPHRAGM | 2 |
| | 286.018.357 | DIAPHRAGM | 2 |
| | 286.018.360 | DIAPHRAGM | 2 |
| | 286.018.365 | DIAPHRAGM | 2 |
| 22 | 312.015.155 | ELBOW, SUCTION | 2 |
| 23 | 312.016.155 | ELBOW, DISCHARGE | 2 |
| 24 | 334.020.000 | FLANGE, FOLLOWER | 4 |
| 25 | 338.008.360 | FLAP VALVE | 4 |
| | 338.008.365 | FLAP VALVE | 4 |
| | 338.011.354 | FLAP VALVE | 4 |
| | 338.011.356 | FLAP VALVE | 4 |
| | 338.011.357 | FLAP VALVE | 4 |
| 26 | 360.010.425 | GASKET, END CAP | 2 |
| 27 | 360.013.379 | GASKET, FLANGE | 4 |
| | 360.013.384 | GASKET, FLANGE | 4 |
| 28 | 360.014.379 | GASKET, FLANGE | 4 |
| | 360.014.384 | GASKET, FLANGE | 4 |
| 29 | 360.021.000 | GASKET | 4 |

Repair Parts shown in **bold face (darker)** type are more likely to need replacement after extended periods of normal use. They are readily available from most Warren Rupp distributors. The pump owner may prefer to maintain a limited inventory of these parts in his own stock to reduce repair downtime to a minimum.

IMPORTANT: When ordering repair parts always furnish pump model number, serial number and type number.

MATERIAL CODES
The Last 3 Digits of Part Number

- 000...Assembly, sub-assembly; and some purchased Items
- 010...Cast Iron
- 012...Powered Metal
- 015...Ductile Iron
- 020...Ferritic Malleable Iron
- 025...Music Wire
- 080...CarbonSteel AISI B-1112
- 100...Alloy 20
- 110...Alloy Type 316 Stainless Steel
- 111...Alloy Type 316 Stainless Steel (Electro Polished)
- 112...Alloy "C"
- 113...Alloy Type 316 Stainless Steel (Hand Polished)
- 114...303 Stainless Steel
- 115...302/304 Stainless Steel
- 117...440-C Stainless Steel (Martensitic)
- 120...416 Stainless Steel (Wrought Martensitic)
- 123...410 Stainless Steel (Wrought Martensitic)
- 148...Hardcoat Anodized Aluminum
- 149...2024-T4 Aluminum
- 150...6061-T6 Aluminum
- 151...6063-T6 Aluminum
- 152...2024-T4 Aluminum (2023-T351)
- 154...Almag 35 Aluminum
- 155 or 156...356-T6 Aluminum
- 157...Die Cast Aluminum Alloy #380
- 158...Aluminum Alloy SR-319
- 159...Anodized Aluminum
- 162...Brass, Yellow, Screw Machine Stock
- 165...Cast Bronze, 85-5-5-5
- 166...Bronze SAE 660
- 170...Bronze, Bearing Type, Oil Impregnated
- 180...Copper Alloy
- 310...Kynar Coated
- 330...Zinc Plated Steel
- 331...Chrome Plated Steel
- 332...Electroless Nickel Plated
- 335...Galvanized Steel
- 336...Zinc Plated Yellow Brass
- 337...Silver Plated Steel
- 340...Nickel Plated
- 342...Filled Nylon
- 354...Injection Molded #203-40 Santoprene
- Duro 40D ± 5; Color: RED
- 355...Thermoplastic Elastomer
- 356...Hytre
- 357...Polyurethane
- 358...Polyurethane
(Some Applications, Compression Mold)
- 359...Urethane Rubber
- 360...Buna-N Rubber Color coded: RED
- 361...Buna-N
- 363...Viton (Fluorel) Color coded: YELLOW
- 364...E.P.D.M. Rubber Color coded: BLUE
- 365...Neoprene Rubber Color coded: GREEN
- 370...Butyl Rubber Color coded: BROWN
- 371...Philtane (Tuftane)

List continued next page

| ITEM NO. | PART NUMBER | DESCRIPTION | QTY. |
|----------|-------------|------------------------|------|
| 30 | 360.041.379 | GASKET, VALVE BODY | 1 |
| 31 | 360.048.425 | GASKET, VALVE BODY | 1 |
| 32 | 518.014.156 | MANIFOLD | 2 |
| 33 | 545.007.330 | NUT, HEX - 7/16-14 | 20 |
| 34 | 545.008.330 | NUT, HEX, 1/2-13 | 24 |
| 35 | 547.002.110 | NUT, STOP | 8 |
| 36 | 547.006.330 | NUT, STOP | 2 |
| 37 | 560.001.360 | O-RING | 2 |
| 38 | 560.020.360 | O-RING | 6 |
| 39 | 560.022.360 | O-RING | 2 |
| 40 | 570.002.360 | PAD, HINGE | 4 |
| | 570.002.365 | PAD, HINGE | 4 |
| 41 | 570.012.371 | PAD, WEAR | 2 |
| 42 | 612.014.000 | PLATE, DIAPHRAGM | 2 |
| 43 | 612.015.156 | PLATE, OUTER DIAPHRAGM | 2 |
| 44 | 618.003.330 | PLUG, PIPE, 1/4 | 2 |
| 45 | 618.004.330 | PIPE, PLUG | 2 |
| 46 | 620.011.114 | PLUNGER, ACTUATOR | 2 |
| 47 | 670.006.115 | RETAINER, FLAP VALVE | 4 |
| 48 | 685.008.120 | ROD, DIAPHRAGM | 1 |
| 49 | 720.004.360 | SEAL, U-CUP | 2 |
| 50 | 722.007.010 | SEAT, FLAP VALVE | 4 |
| 51 | 807.016.330 | 7/16-14 X 3 STUD | 12 |
| 52 | 807.017.330 | 7/16-14 X 3 STUD | 8 |
| 53 | 807.018.110 | STUD, 1/4-20 | 8 |
| 54 | 900.003.330 | WASHER, LOCK, 1/2 | 8 |
| 55 | 900.006.330 | WASHER, LOCK - 7/16 1 | 2 |
| 56 | 901.006.330 | WASHER, FLAT, 1/2 | 12 |
| 57 | 901.011.180 | WASHER | 12 |
| 58 | 901.013.180 | WASHER, SEALING | 2 |
| 59 | 901.023.330 | WASHER, FLAT | 2 |

NOT SHOWN:

| | | |
|--------------|--------------------------------------------------------------------|---|
| 031.019.156. | MAIN AIR VALVE ASSEMBLY (includes items 10, 11, 13, 14, 15 &16) | 1 |
| 901.035.115. | WASHER FLAT (used w/Santoprene Flaps) | 8 |

HDF4-A Type 3

| | | | |
|----|--------------|----------------|---|
| 60 | 545.009.330. | HEX NUT | 8 |
| 61 | 900.007.330. | LOCK WASHER | 8 |
| 62 | 807.005.330. | STUD | 8 |
| 63 | 360.036.426. | FLANGE GASKET | 2 |
| 64 | 334.037.010. | ADAPTOR FLANGE | 2 |

NOT SHOWN:

| | | |
|--------------|------------------------------------|---|
| 770.020.080. | SPACER, FOOT | 4 |
| 901.006.330. | WASHER, FLAT (used w/ foot spacer) | 8 |

Repair Parts shown in **bold face (darker)** type are more likely to need replacement after extended periods of normal use. They are readily available from most Warren Rupp distributors. The pump owner may prefer to maintain a limited inventory of these parts in his own stock to reduce repair downtime to a minimum.

IMPORTANT: When ordering repair parts always furnish pump model number, serial number and type number.

MATERIAL CODES
The Last 3 Digits of Part Number

Continued from previous page

375...Fluorinated Nitrile
378...High density Polypropylene
379...Conductive Nitrile
384...Conductive Neoprene
405...Cellulose Fibre
408...Cork and Neoprene
425...Compressed Fibre
426...Blue Gard
440...Vegetable Fibre
465...Fibre
500...Delrin 500
501...Delrin 570
505...Acrylic Resin Plastic
520...Injection Molded PVDF Natural Color
540...Nylon
541...Nylon
542...Nylon
544...Nylon Injection Molded
550...Polyethylene
551...Polypropylene
552...Unfilled Polypropylene
555...Polyvinyl Chloride
570...Rulon II
580...Ryton
590...Valox
591...Nylatron G-S
592...Nylatron NSB
600...PTFE (virgin material) Tetrafluoroethylene (TFE)
601...Virgin PTFE (Bronze and moly filled)
602...Filled Virgin PTFE
603...Blue Gylon
604...Virgin PTFE
606...Virgin PTFE
608...Conductive PTFE
610...Virgin PTFE Encapsulated Silicon
611...Virgin PTFE Encapsulated Viton

Delrin, Viton and Hytrel are registered tradenames of E.I. DuPont.

Gylon is a registered tradename of Garlock, Inc.

Nylatron is a registered tradename of Polymer Corp.

Rulon II is a registered tradename of Dixon Industries Corporation.

Hastelloy-C is a registered tradename of Cabot Corp.

Ryton is a registered tradename of Phillips Chemical Company.

Valox is a registered tradename of General Electric Company.

Warren Rupp, Rupplon, SANDPIPER, PortaPump, Tranquilizer, and SludgeMaster are registered tradenames of Warren Rupp Inc.

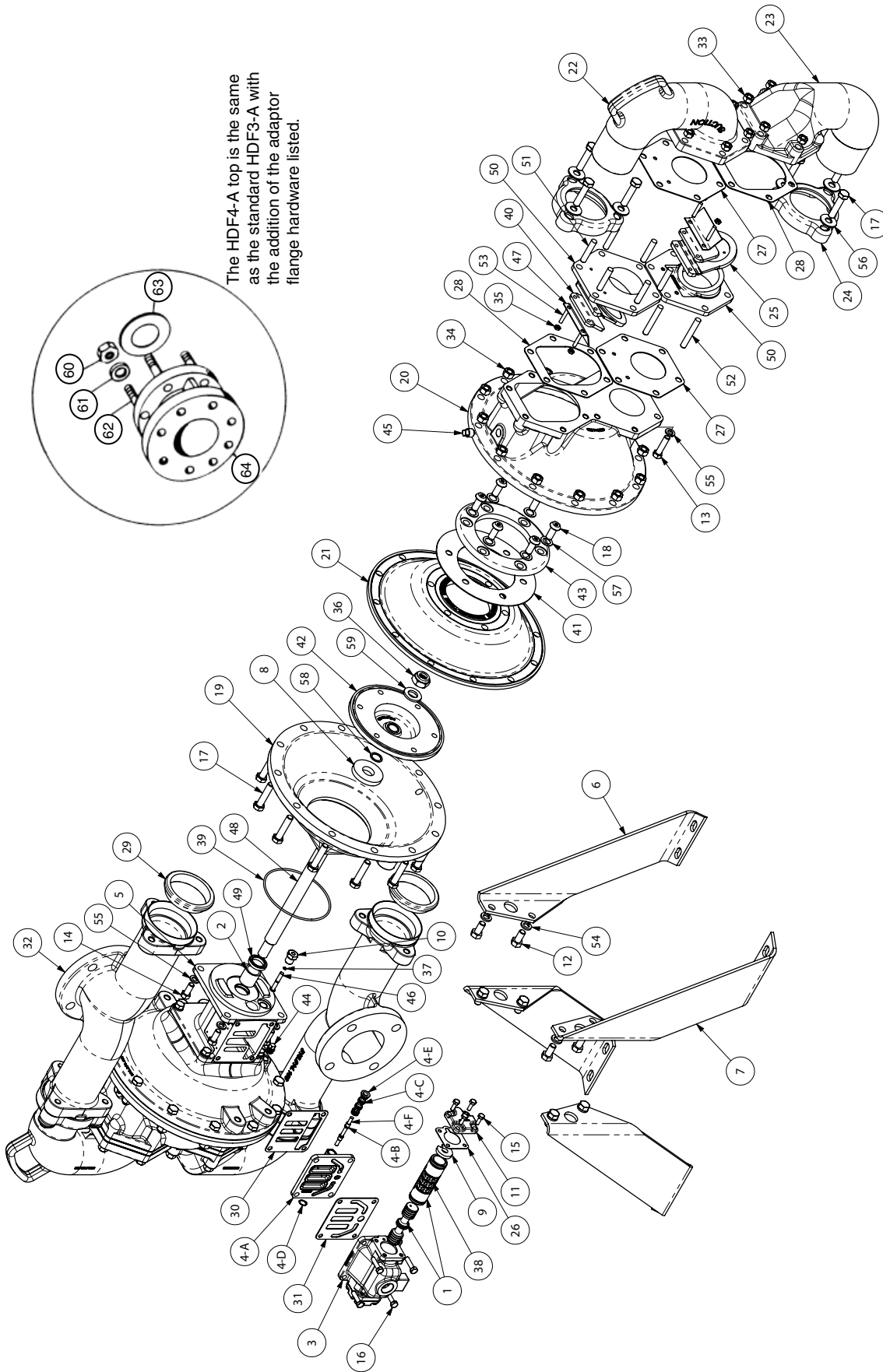

The HDF4-A top is the same as the standard HDF3-A with the addition of the adaptor flange hardware listed.

©2009 Warren Rupp, Inc. All rights reserved.

©Warren Rupp and SANDPIPER are registered trademarks of Warren Rupp, Inc.

Printed in U.S.A.